

ESRP-CMS-U238V2

Multi-display ThinManager Ready Thin Client

NEW



Features

- Fanless Multi-display Industrial Thin Client with wide operating temperature range from -20 to 60°C
- Verified with ThinManager, ThinManager BIOS enabled
- Multiple displays (HDMI*1, DP*1, USB Type-C*2)
- ThinManager ready for firmware package 13.2.0-9.4 or later; TermCap 9.13.2.101 for ThinManager 11.2 and earlier; or TermCap2 13.2.101 for ThinManager 12.0 and later

Introduction

Advantech ThinManager compatible industrial thin clients exclusively integrate with ThinManager® software and are verified for ThinManager distributed applications. The thin clients are used to display content delivered from a remote ThinManager server. Multiple thin clients set up across the plant or facility with various roles and all maintained by the ThinManager server. All content remains on the server so downtime is reduced in the event of a failure. ESRP-CMS-U238V2 is ThinManager Ready Compact IoT Edge Computer with Intel® Core™ i and four displays (HDMI *1, DP*1, USB Type-C*2).

Specifications

General

- **Certification** CE, FCC Class A, UL, CCC, BSMI
- **Dimensions (W x D x H)** 150 x 107 x 60 mm (5.91 x 4.22 x 2.36 in)
- **Form Factor** Small
- **Enclosure** Aluminum housing
- **Mount Options** Stand, DIN-rail (optional)
- **Weight (Net)** 1.8 kg (3.9 lb)
- **Power Requirement** 12 V_{DC} 7A (support ErP), 19 V_{DC} 4.5A (AC to DC adapter is included)
- **Power Consumption** 30-60W

System Hardware

- **BIOS** ThinManager enabled BIOS
- **Watchdog Timer** Programmable timer with 255 intervals (1 ~ 255 sec)
- **TPM** TPM 2.0
- **Processor** Intel® i3-1215UE (6 cores), 1.2 GHz (up to 4.4 GHz)
- **Memory** DDR5 4800 8GB
- **Graphics Engine** Intel® Iris Xe® Graphics
- **Ethernet** LAN A: Intel® i226-LM, 10/100/1000/2500Mbps
LAN B: Intel® i219-LM, 10/100/1000Mbps
- **LED Indicators** Power only

I/O

- **LAN** 2 x RJ-45
- **USB** - 4 x USB 3.2 (Gen2 10Gbps)
- 2 x USB Type-C (USB3.2 Gen2)
- **Displays** 1 x HDMI standard 2.0 (up to 4096 x 2160 @60 Hz)
1 x DP 1.4a (up to 4096 x 2304 @60 Hz)
2 x USB Type-C, need additional dongles for display option
for HDMI up to 4096 x 2160 @60 Hz;
or for DP up to 4096 x 2304 @60 Hz
- **Power Connector** 1 x Terminal block

Environment

- **Operating Temperature** -20 ~ 60 °C with 0.7 m/s airflow
- **Storage Temperature** -40 ~ 85 °C / -40 ~ 185 °F
- **Relative Humidity** Operating, 95% RH @ 40°C, non-condensing
Non-operating, 95%RH @ 60°C, non-condensing
- **Shock Protection** Operating, IEC 60068-2-27, 50G, half sine, 11 ms
- **Vibration Protection** Operating, IEC 60068-2-64, 2 Grms, random, 5 ~ 500 Hz, 1hr/axis

Ordering Information

- **ESRP-CMS-U238V2** Multi-display ThinManager Ready Thin Client
- **UNO-200-DMKAE** DIN-Rail kit
- **1702002600** Power cable US plug, 1.8 M (industrial grade)
- **1702002605** Power cable EU plug, 1.8 M (industrial grade)
- **1702031801** Power cable UK plug, 1.8 M (industrial grade)

Packing list

- **XUNO-FSP084-DHAN3** 84W 12V Adapter

Installation Scenario

Wall/Stand Mount

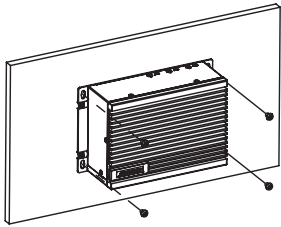

Wall Mount

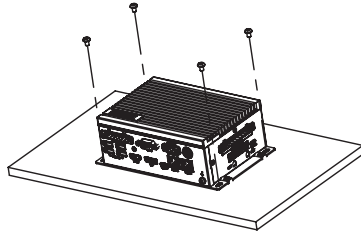

Stand Mount

Din-Rail Mount (with optional DIN-rail kit)

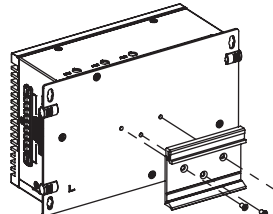

DIN-Rail Assembly

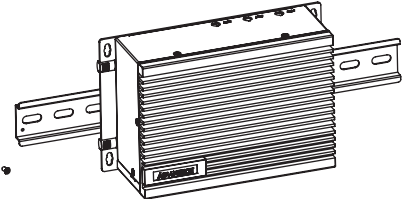

DIN-Rail Installation

Dimensions

Unit: mm

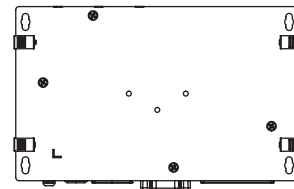
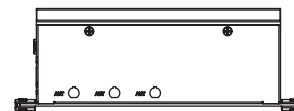
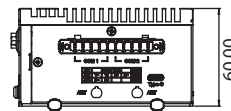
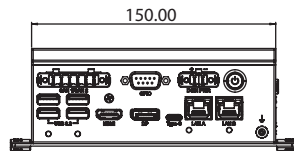
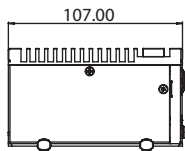
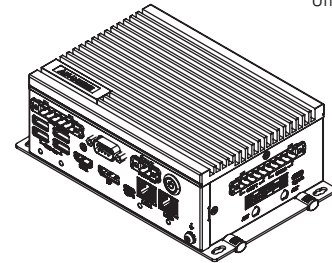
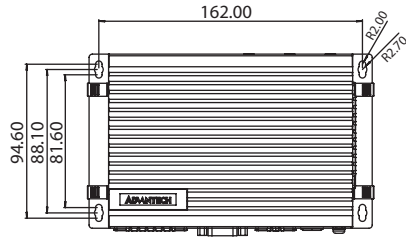

Front I/O

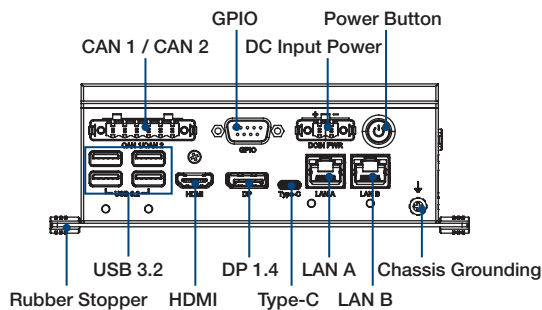

Right I/O

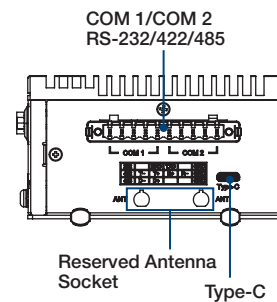

Please note: If some optional modules are offered with the system, additional system certificates may be required in certain regions/countries. Please contact Advantech for certificate compliance.